



— HVAC MATERIALS —

OUR DUTIES (7:30 TO 22:30)

0504613160



VARIOUS SHAPES

AIR GRILLE



A grille is a perforated cover for an air duct and sometimes have louvers which allow the flow of air to be directed.



AIR FILTER

- 2020 -

MANUFACTURING
AND
DISTRIBUTION

OF AIR FILTERS
WHICH GIVES THE
EFFICIENCY OF AIR
FILTERS THAT
CLEAN THE
AIR WE BREATHE.



FIND US

JALSY2@GMAIL.COM

0504613160

-Polyisocyanurate (PIR)
foam panel, coated with
pure embossed aluminium
foil.

-Three panel types:

PIR-ALU 20/35: 20mm
thickness

PIR-ALU 30/35: 30mm
thickness

PIR-ALU 20/45: 20mm
thickness

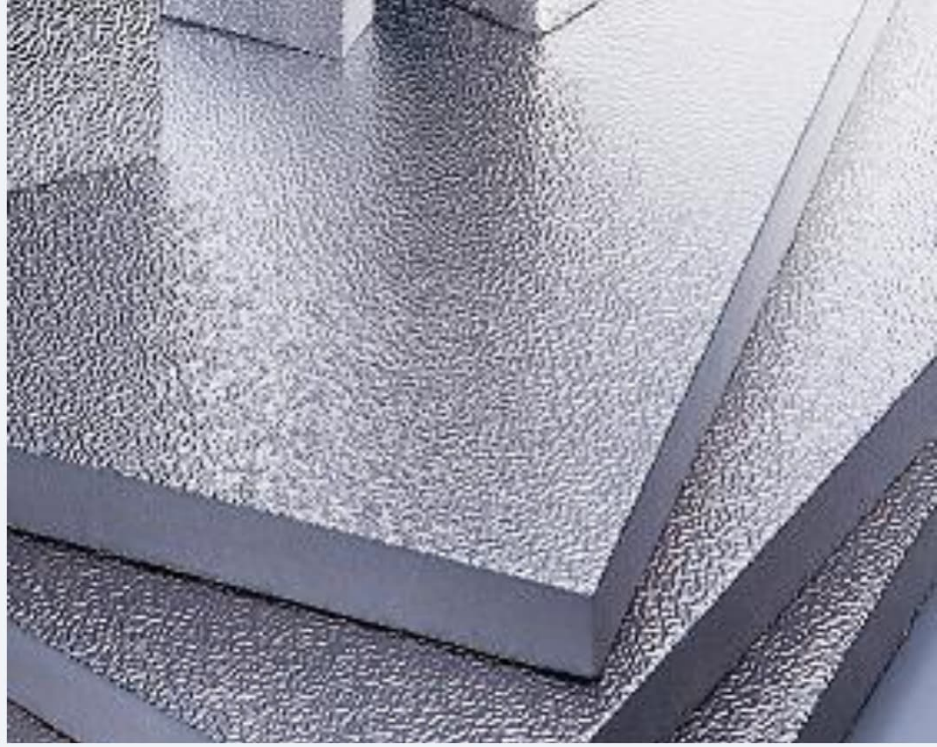

-For construction
of air ducting in
heating, ventilation
and air-conditioning
systems (HVAC).



PREINSULATED
DUCT
AVAILABLE NOW



 **جام**
JAAM
0504613160





لأنظمة التكييف

JAAM HVAC

Accessories of preinsulated duct



3360

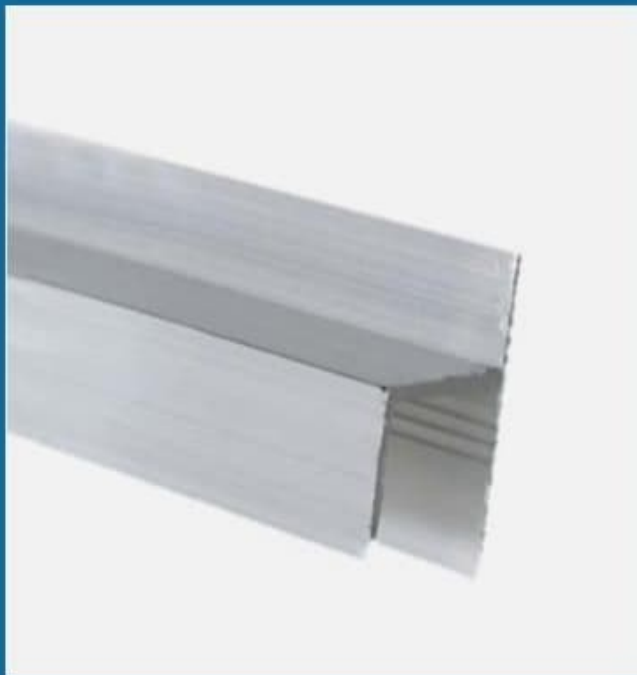
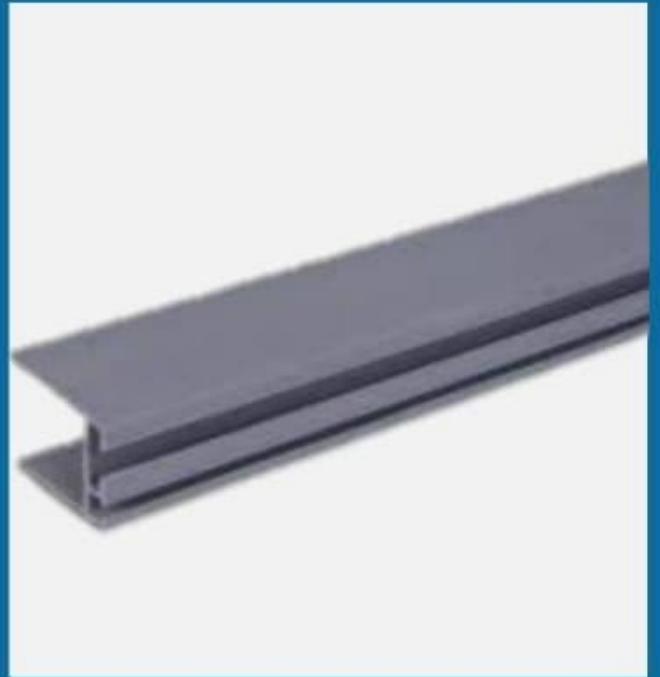



HVAC Materials

Supply,
fabrication, and
testing of
G.I. ductwork
and sheet
metal complete
with accessories
for HVAC
systems.

Available
now
0504613160





HVAC materials

All what you need to install GI duct

0504613160

HVAC Metal Damper Quadrant Handle



These heavy gauge Plated Steel quadrants are designed with excellent handle action as well as quick wing nut adjustment and locking of the damper. For use on square or round ducts.



*Available
now*



لأنظمة التكييف

0504613160



Ductmate Flange - HVAC Ducts

Strong and virtually leak-free rectangular duct connection systems. Ductmate connection systems consist of roll-formed flanges, corner pieces, gasket, and cleat.

Thickness: 20mm & 30mm

Length: 5mtr

Other sizes be produced according to customer's drawing.



**AVAILABLE
NOW
0504613160**

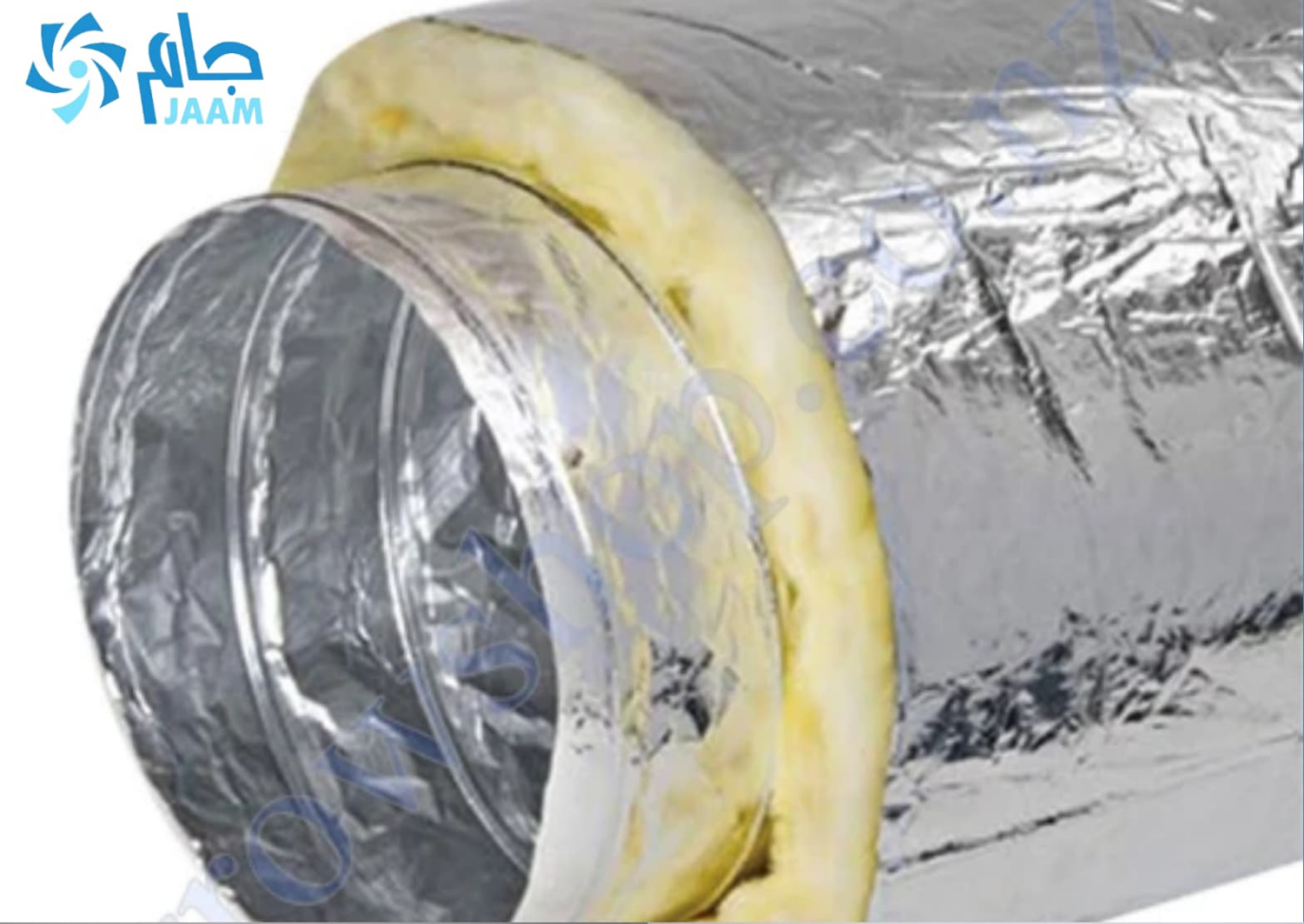

Flexible duct

The double-ply insulated material of this HVAC air duct allows it to function well in temperature ranges between -20°F and 160°F .

Available now with different sizes.

0504613160



Aluminum Duct

Ventilation

Suitable for high, medium and low pressure applications compared to aluminum foil duct. Can be used for exhaust venting bathroom vents, clothes dryers, range hoods, fireplace etc.





Duct connector

All air duct installations for HVAC systems are attached to mechanical equipment containing a fan or blower. Vibrations are transmitted into the duct which carry the noises throughout the system. an air-tight flexible joint, must be inserted between the equipment and the ductwork.

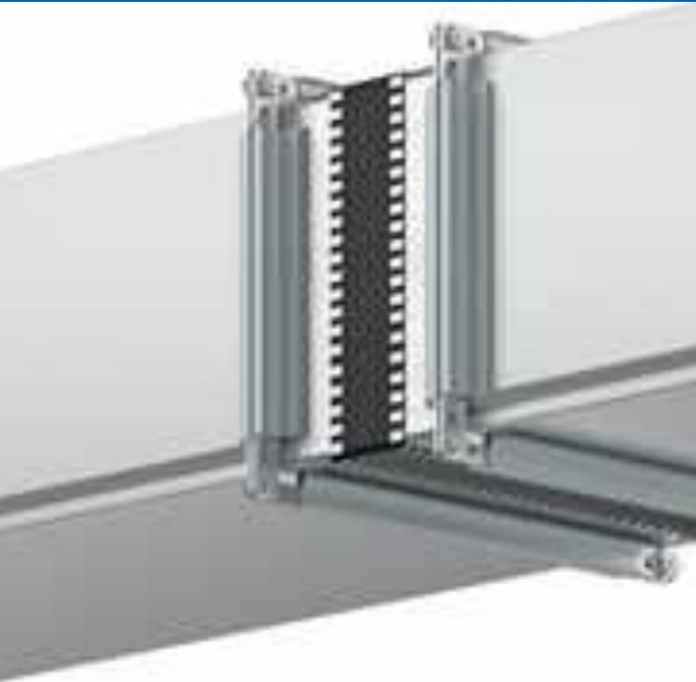

**FLEXIBLE
CONNECTION**

0504613160



HVAC MATERIALS



Aluminum foil
tape



Duct
tape





Duct insulation

EXTERNAL INSULATION OF
RECTANGULAR
AND CIRCULAR AIR DUCTING
AND AIR HANDLING
EQUIPMENT.
WITH ALL SIZES.
AVAILABLE NOW

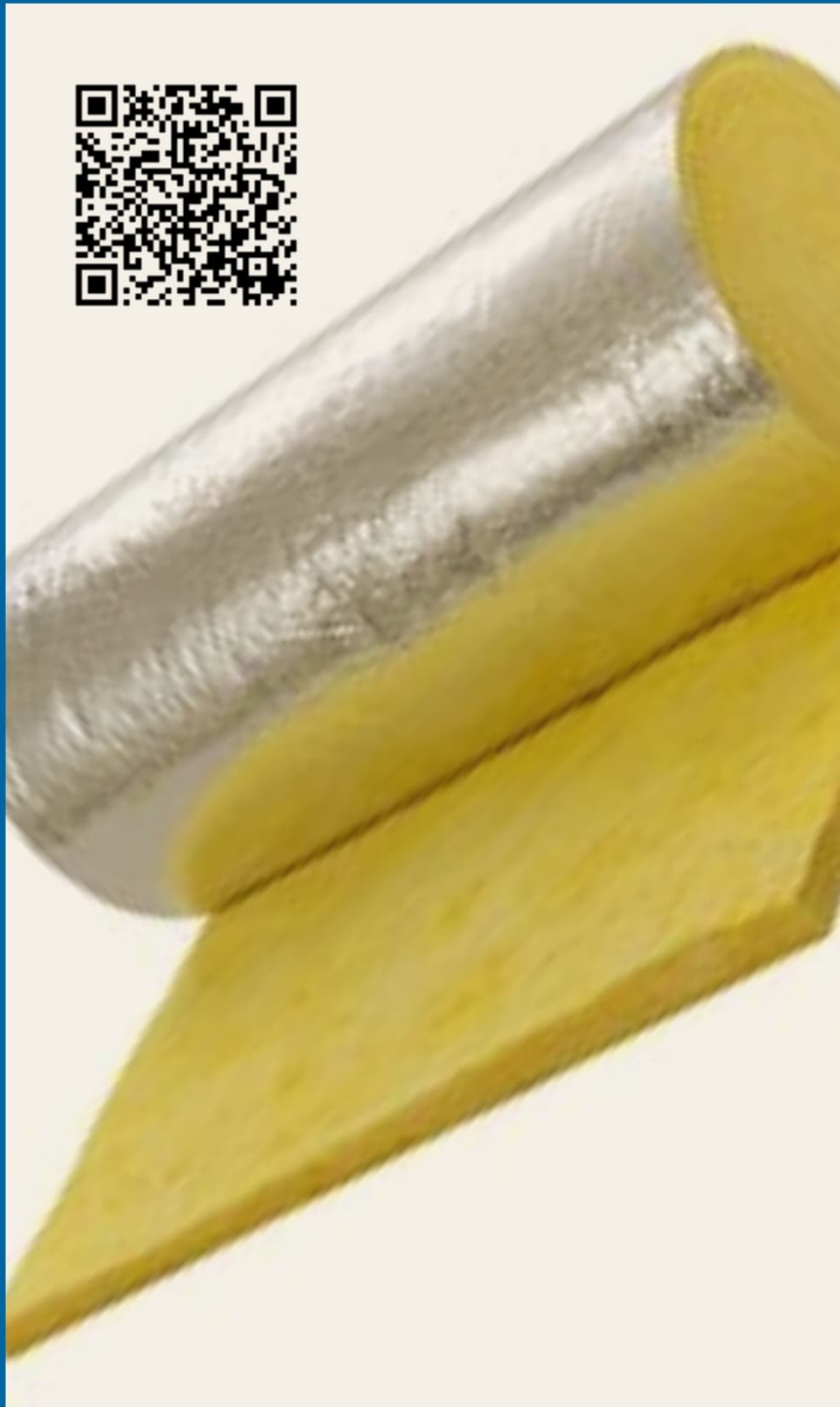



A thermostat is a component which senses the temperature and performs actions so that temperature is maintained near a desired setpoint.

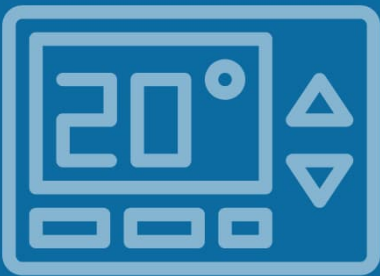

Honeywell programmable thermostats

Available now



0504613160



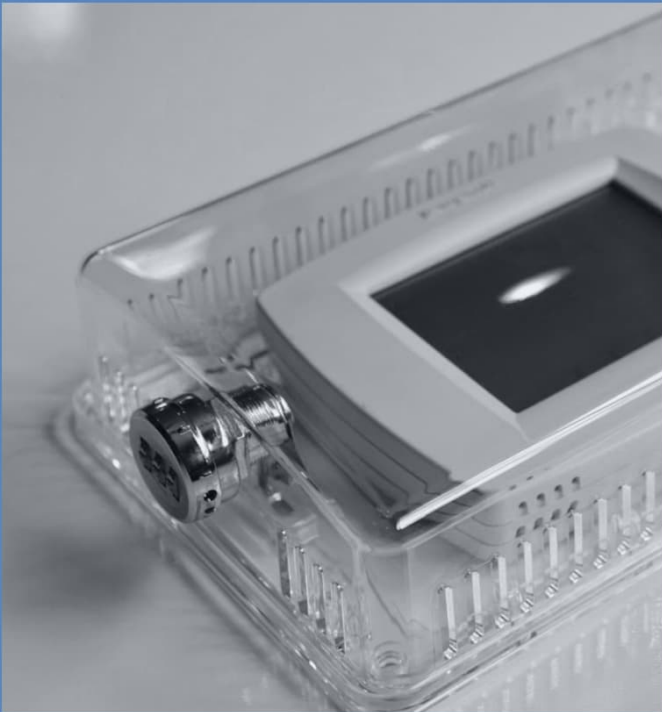
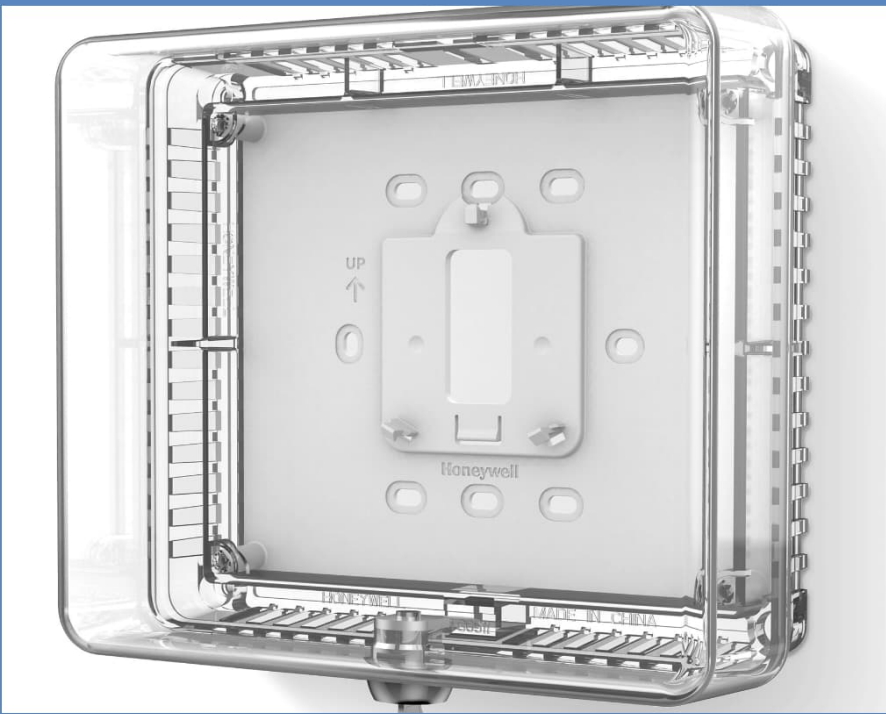

CLEAR PLASTIC THERMOSTAT GUARD





REMOTE

UNIVERSAL AC REMOTE CONTROL





Universal Air
Conditioner
PCB Board
with AC Remote
Control System.

REFRIGERANT
22
Chlorodifluoromethane
(CHCLF₂)
30lbs.NET WEIGHT:(13.6kg)

INSTRUCTIONS FOR USE
For use by trained and experienced personnel only.
... charging hose direct to service valve...
... connected to the high pressure side of system...

INSTRUCTIONS FOR DISPOSAL
Do not vent residual contents to the atmosphere.
Recover residual contents of this cylinder with approved refrigerant recovery unit. When empty (RPSIG or less) open valve, pull out and dispose properly. Do not incinerate or reuse. Please recycle.
Federal law forbids transportation in this pack.™ ... is \$ 25,000 fine and five years...

REFRIGERANT
22
CHLORODIFLUOROMETHANE
CAS 75-4-4
NON-FLAMMABLE L



UN 1018

INSIDE PACKAGE COMPLIES WITH
NON-REFILLABLE
30LBS. ◀ NET WE



Special offer · Free delivery



REFREGRANT 410A

Newer air conditioning models are designed to be used with R-410A for reliable and more efficient operation. Because R-410A can absorb and release more heat than R-22, your air conditioning compressor can run cooler, reducing the risk of compressor burnout due to overheating.

R-410A also functions at a higher pressure than R-22, so new compressors are built to withstand greater stresses, reducing the chance for cracking. If you were to put R-410A refrigerant into a system designed for R-22, the pressure would be too much and the unit would break.

All air conditioners use an oil to keep the compressor lubricated during operation. R-22 air conditioners use mineral oil and R-410A systems use synthetic oil. The synthetic oil is generally more soluble with R-410A than mineral oil is with R-22. This means the R-410A system operates more efficiently reducing wear and tear on the compressor.

All compressors
sizes are available



Copeland[®]
brand products

Danfoss



Tecumseh

The Tecumseh logo consists of a blue stylized profile of a Native American man's head with feathers, positioned above the brand name 'Tecumseh' in a blue, cursive font.

LG

The LG logo features a red circle containing a white stylized 'L' and 'G' intertwined, followed by the letters 'LG' in a bold, black, sans-serif font.



لأنظمة التكييف

Filter driers

Filter driers are devices used in a HVAC system to remove any particle such as dirt, metal or chips from entering the refrigerant flow control.

**Available now
0504613160**





**COPPER
PIPES**
MADE IN USA

**COPPER TUBING
IS USED AS A
REFRIGERANT
LINE IN HVAC SYSTEMS.
ALL SIZES
AVAILABLE
NOW IN OUR SHOP**





Insulated copper pipe 5m made in China
All sizes are available now
ready to install AC





HVAC MATERIALS

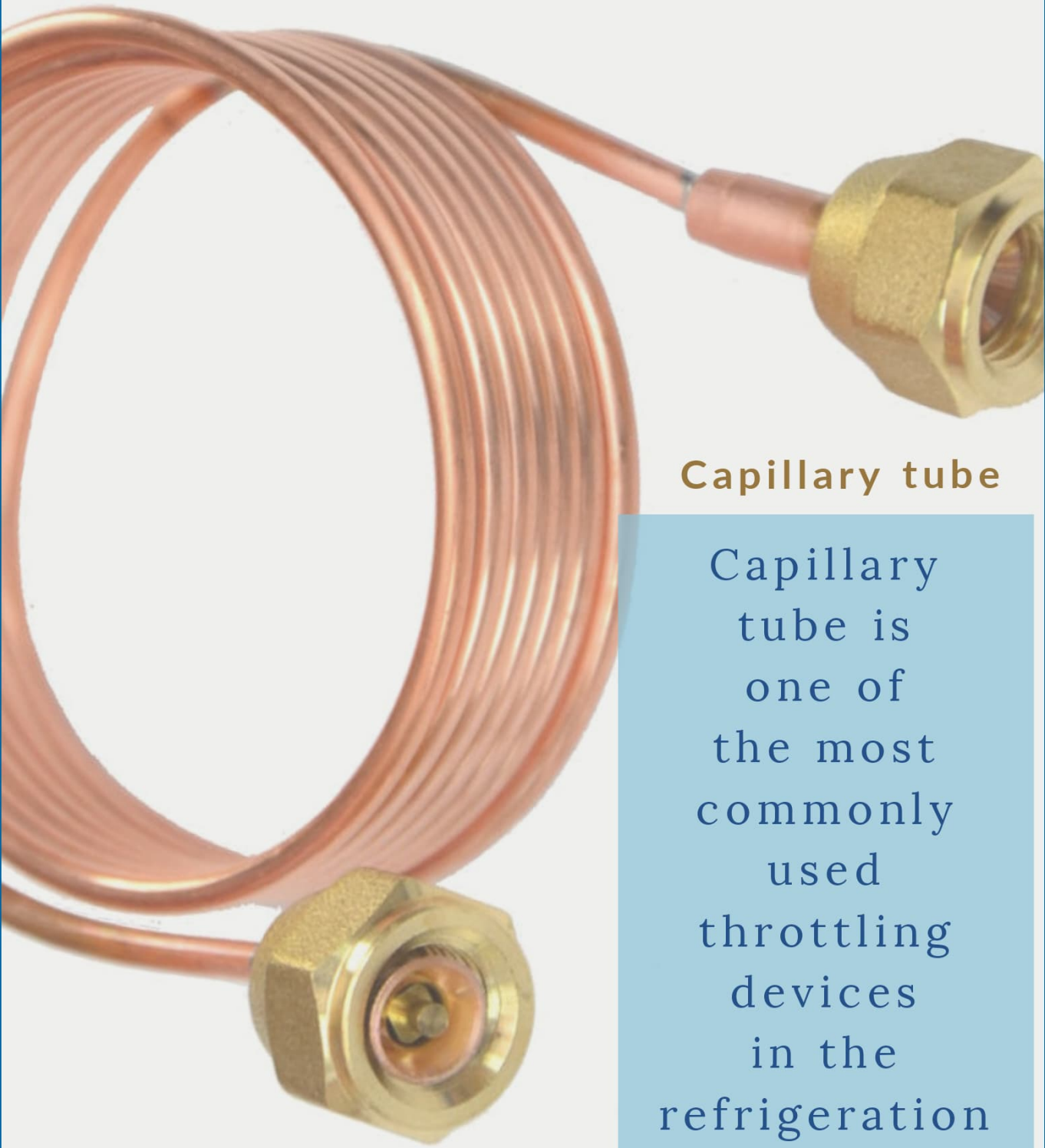

Capillary tube

Capillary tube is one of the most commonly used throttling devices in the refrigeration and the air conditioning systems.





Copper fitting

Offering High
Standard Quality
Copper Pipe Fittings,
all Size
Available now



CHARGING VALVE

COPPER ACCESS VALVE, 1/4"

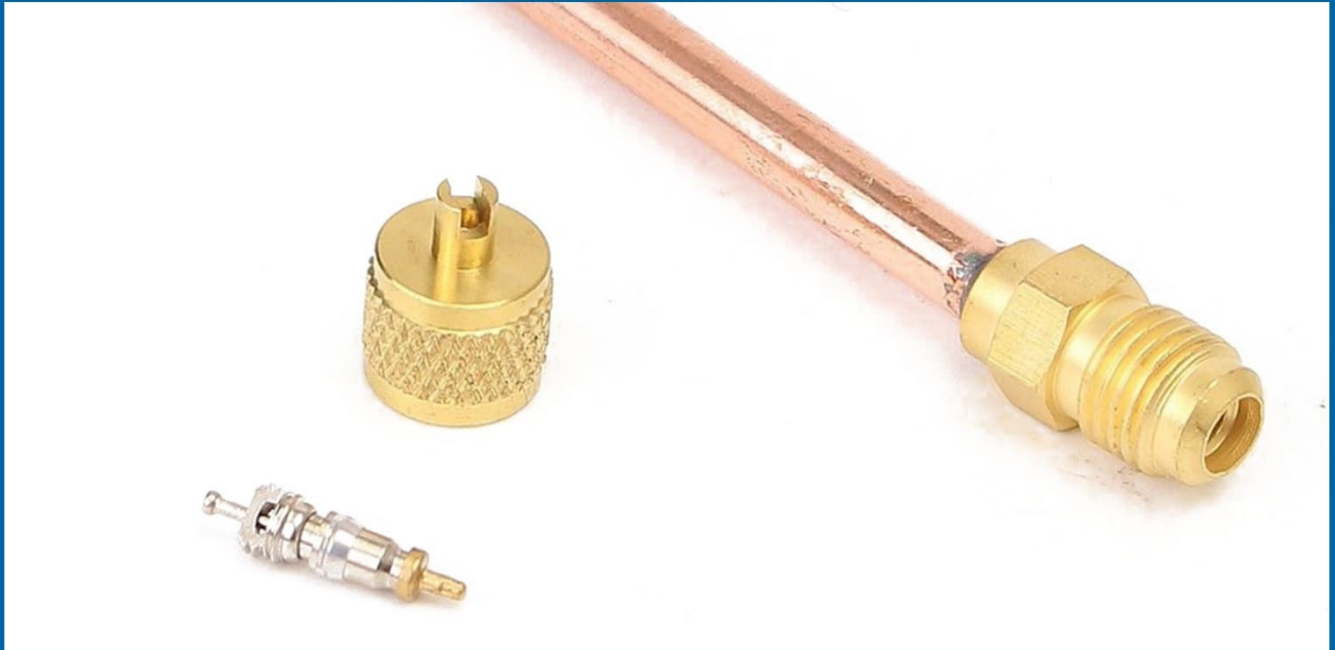

These valves are especially designed for charging of refrigerant and for checking the pressure of airconditioning systems.

Compatible for: R12, R22, R407c, R134a,
R290,R600,R410a

>B< MAXIPRO
IS A ROBUST
PRESS SYSTEM,
WHICH
IS QUICK
AND SIMPLE
TO USE
PROVIDING
A SECURE
AND PERMANENT
JOINT.
AVAILABLE
IN OUR
SHOPS WITH
DIFFERENT
SIZES AND
SHAPES.



JUST CALL OR SEND A MESSAGE.
FOR FREE DELIVERY.



*JAAM +966504613160 HERA STREET,
JEDDAH, SAUDI ARABIA*



TORCH AND
WELDINGS



Brand: HARRIS
Made in: USA
0% Silver Phos
Copper Solder
Brazing Alloy.





FIND THE MOST
IMPORTANT
HVAC TOOLS AND
EQUIPMENT THAT EVERY
HVAC TECH NEEDS.

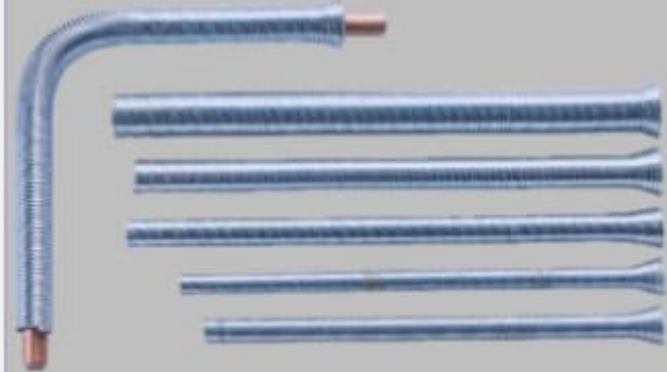

0504613160

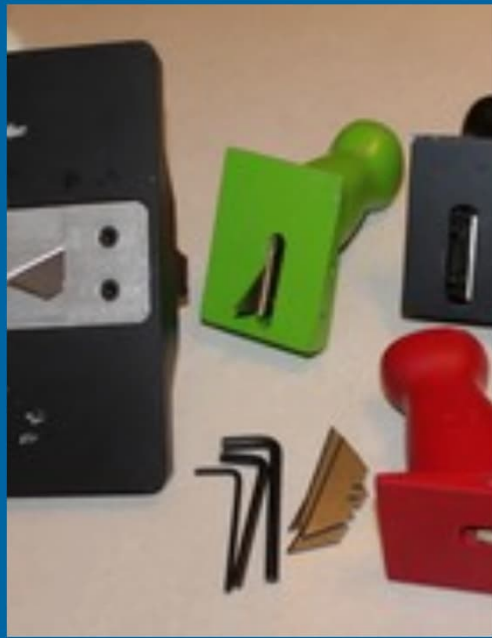

cutting tools for pre insulated duct panel

Double 45°/ Cutter /Jack Plane with 45° Dual Blades

Left 45°Cutter /Jack Plane Left with 45° Single Blade

Right 45° Cutter /Jack Plane Rightwith 45° Single Blade

90° Cutter /Jack Plane 90° Single Blades

A complete set of professional hand tools and manual fabrication equipment has been specifically developed to enable the efficient and economical fabrication of phenol polyurethane/ PIR pre-insulated ductwork. Ease of portability provides the option for on-site fabrication.



0504613160



WELLDING & BRAZING

JAAM HVAC materials

*Portable Welding
Torch Kit with Oxygen
and Acetylene Tanks*

Give us a call!

050-461-3160

Jalsy2@gmail.com



Available now in our shops



Capacitor

Capacitors are small cylindrical objects that store energy.



ALL TYPES OF AC
CAPACITOR AVAILABLE AT OUR SHOP

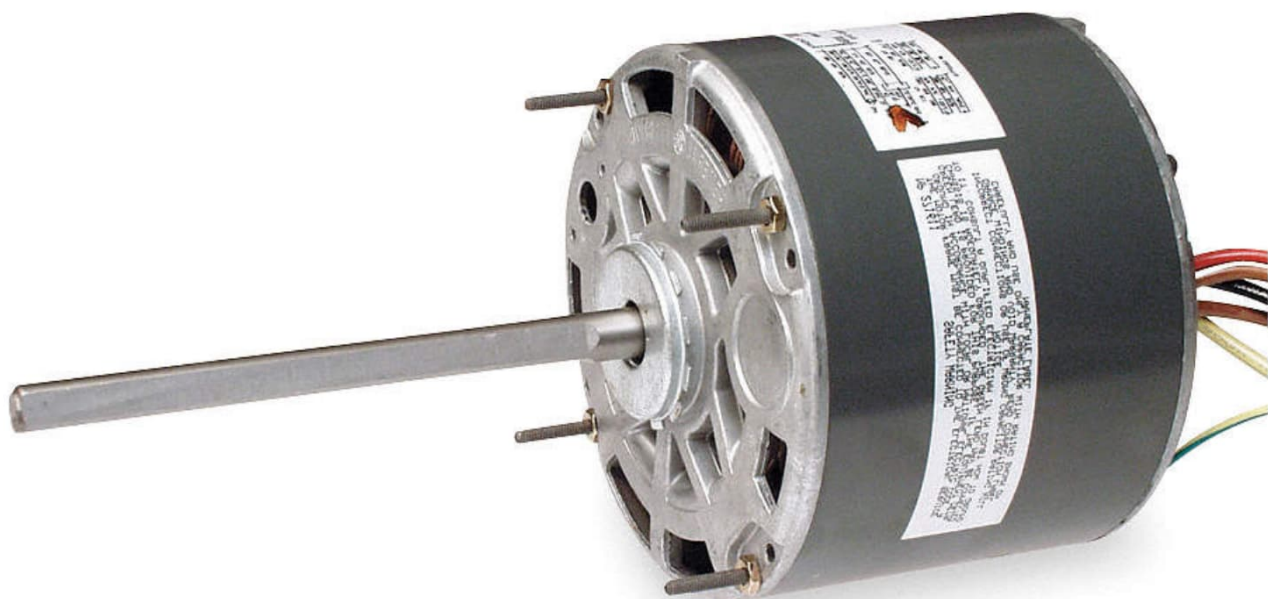

HVAC Materials
AC & DC
FAN
MOTORS



0504613160

FAN BLOWER

There are two fans in an AC: the indoor blower fan that sends air from the return vents past the evaporator coil and the outdoor fan that pulls in exterior air and exhausts heat.



AVAILABLE
WITH
DIFFERENT
SIZES



All types of Contactors



0504613160

JAAM

لأنظمة التكييف
Air Conditioning & Electro-Mechanical



Temperature sensor

TEMPERATURE SENSOR IS AN ELECTRONIC DEVICE THAT MEASURES THE TEMPERATURE OF ITS ENVIRONMENT AND CONVERTS THE INPUT DATA INTO ELECTRONIC DATA TO RECORD, MONITOR, OR SIGNAL TEMPERATURE CHANGES.

*AVAILABLE
NOW
0504613160*





HVAC Materials

Wonder Black pvc Corrosion
Protection Pipe Wrap
Tape 0.2mm x 2"

Available in our shops

0504613160



Insulation sheet

Different sizes



Insulation for piping

Are you looking for a new HVAC products? Just call
0504613160



**RUBBER
INSULATION**





Gastek foam tape

Foam insulation tape are easy to cut into different shapes and sizes for any application, shock-absorbing, sound and HVAC insulation.

Available now

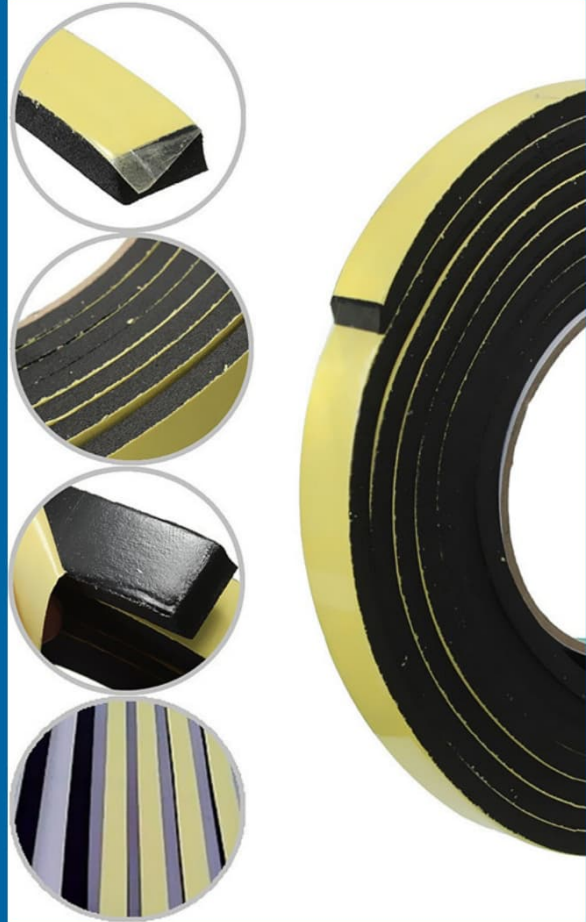
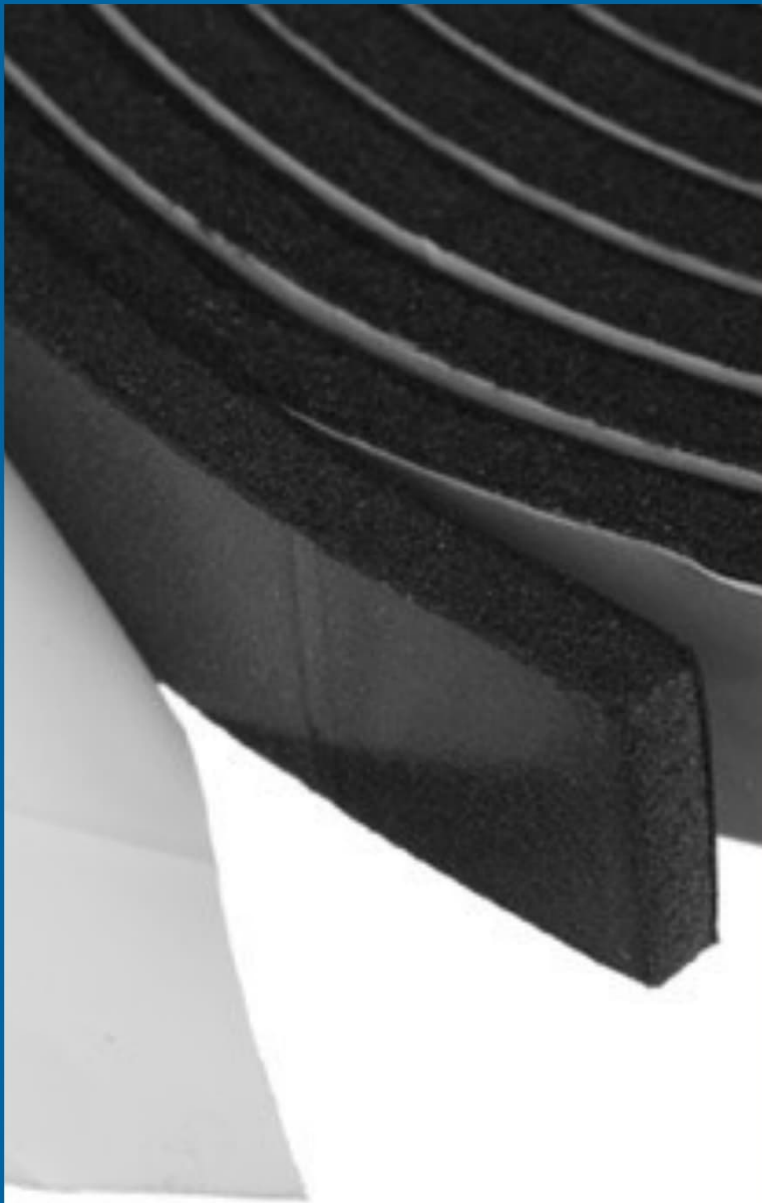



SILICONE FOR DUCT SEALANT

AVAILABLE
NOW

2020 | JEDDAH, SAUDI ARABIA

0504613160 - JALSY2@GMAIL.COM

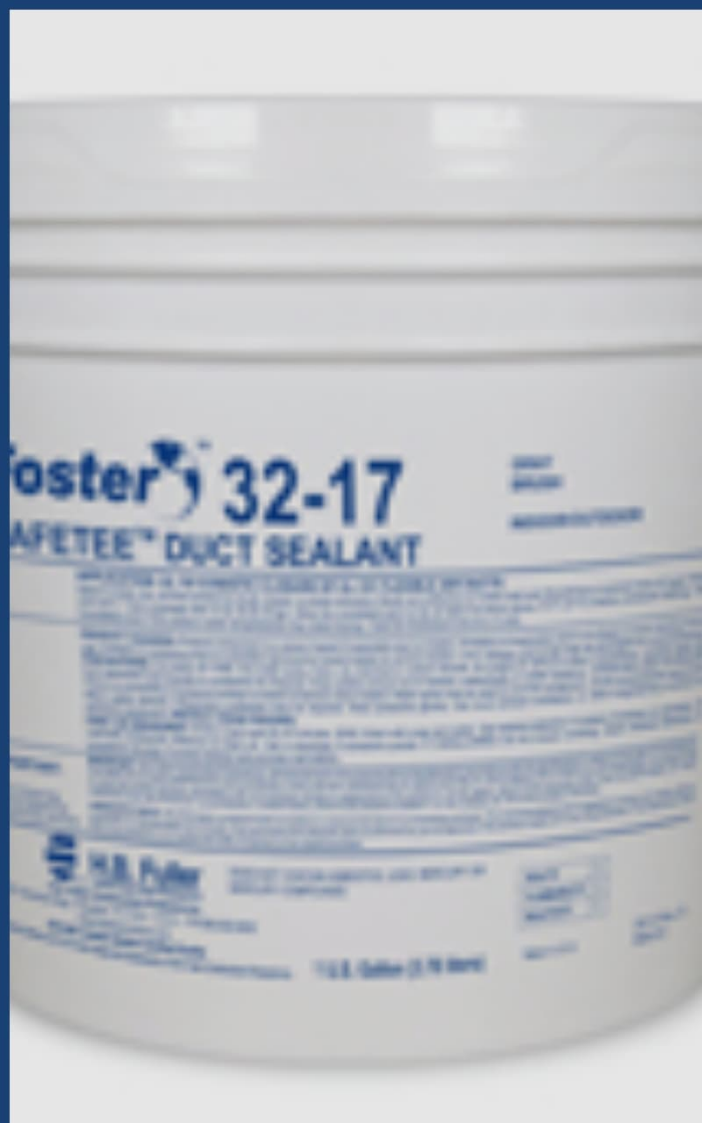



AIR CONDITIONING BRACKETS

Available with different sizes
050 4613160

Outdoor Mounting Bracket for Split
Air Conditioner Heat Pump Systems,
Universal, 9000-36000Btu Condenser

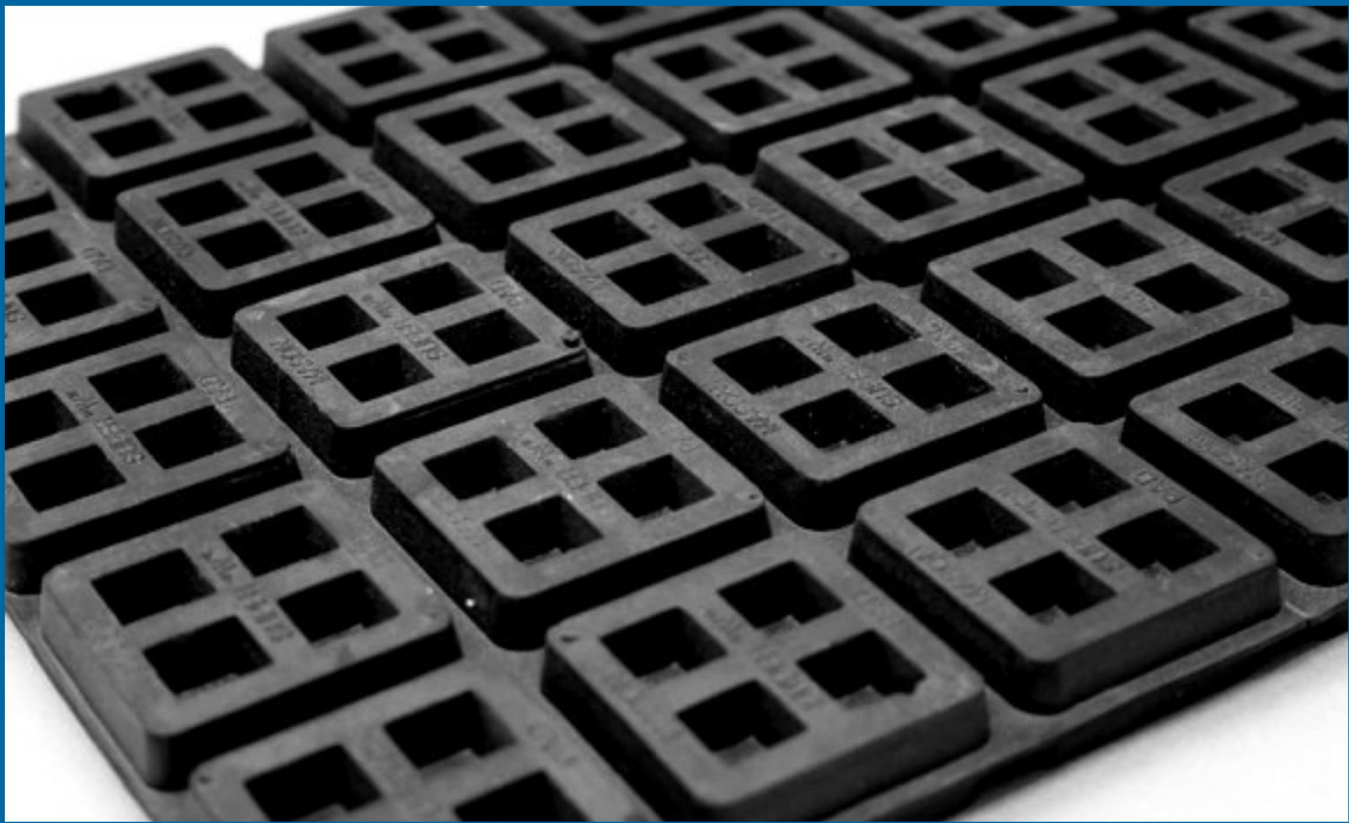

Anti vibrations pads

Housed Vibration Isolator Spring Mount, and
Anti Vibration Rubber & Cork isolation pads.



0504613160

- SPARE PARTS & ACCESSORIES -

“JAAM for HVAC materials”



*Anti Vibration Pads,
Rubber Pads Vibration
Absorbing for AC Plastic
and Rubber Mounting,
Bracket for Outdoor
Units.*



0504613160





Cleaning condenser coils on your outdoor AC unit will not only help the unit cool more efficiently, but it will also cut down on the power



Find cleaning products in our shops



For daily work



**DISPOSABLE
SHOE COVER**

JAAM
HVAC materials



keep cleaning

Against

COVID-19

0504613160

Filters mostly
like this ➡



Air conditioning special cleaning cover

Four upgrades | environmentally friendly fabrics | non-toxic and tasteless | refused to leak

AVAILABLE
NOW





PROVIDES ALL TYPES OF AIR CONDITIONING



TRANE



Fuji Electric



GREE



AVAILABLE
NOW

0504613160



لأنظمة التكييف

HVAC

JAAM

VRF



These are the advantages of a VRF system:

Consistent comfort

Quiet operation

Energy efficiency

Installation flexibility, great for tight spaces

Heat & cool simultaneously

Zoned heating & cooling

State-of-the-art controls

Fewer breakdowns/less downtime

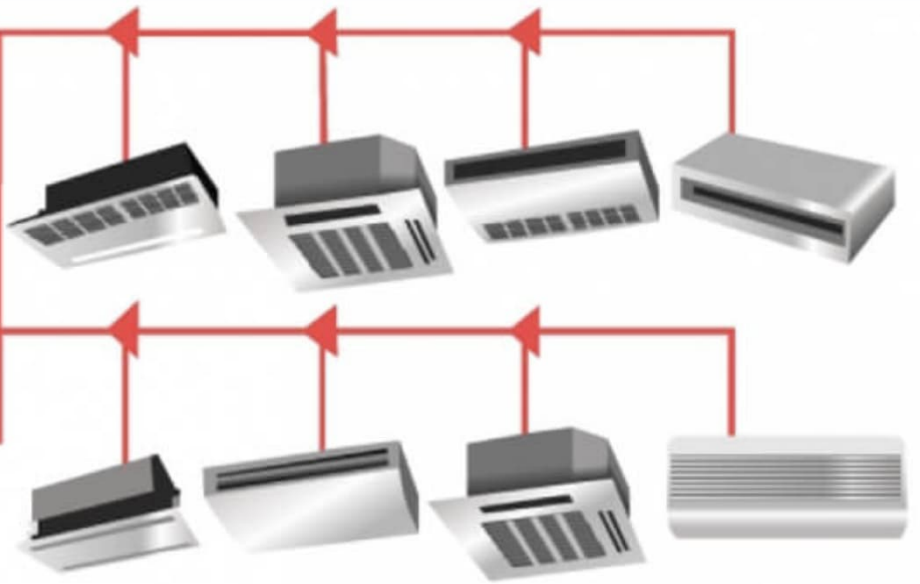

AVAILABLE
NOW

